



Operating Instruction
Centrifugal Pumps LTU · LUB



Please keep your Operating Instruction in a safe place! Translation of the original operating instructions!

Contents

1	General information	3	5	Starting Operation/ Stopping Operation	9
1.1	Design	3	5.1	Preparations for Initial Operation	9
1.2	Intended Use	3	5.2	Initial Starting	9
1.3	Place of Operation	4	5.3	Restarting	9
			5.4	Stopping Operation	9
2	Security	4	6	Service/Maintenance	9
2.1	Identification of Safety Instructions in the Operating Manual	4	6.1	Supervision of Operation	9
2.2	Qualification and Training of Operating Personnel	4	6.1.1	Shaft Bearing	10
			6.1.2	Mechanical Seal	10
2.3	Hazards in the Event of Non-Compliance with the Safety Instructions	4	6.2	Maintenance	10
			6.2.1	Preparation	10
2.4	Compliance with Regulations Pertaining to Safety at Work	5	6.2.2	Dismounting	11
			6.2.2.1	Pump	11
2.5	Safety Instructions relevant for Operation	5	6.2.2.2	Dismounting of Mechanical Seal	11
2.6	Safety Instructions relevant for Maintenance, Inspection and Assembly Work	5	6.2.2.3	Motor	11
			6.2.3	Mounting	11
2.7	Unauthorized Alterations and Production of Spare Parts	5	6.2.3.1	General Remarks	11
			6.2.3.2	Mounting of the Motor	11
2.8	Unauthorized Modes of Operation	5	6.2.3.3	Mounting of Mechanical Seal	12
3	Transport and Intermediate Storage	6	7	Disturbance	13
3.1	Transport	6	8	Pump View and list of Spare Parts	14
3.2	Intermediate Storage	6	8.1	LUB 65 · LUB 80	14
3.2.1	Internal Preservation	6	8.2	LUBL 65 · LUBL 80 · LUBL 100	15
3.2.2	Preservation Control	6	8.3	LTU	16
3.2.3	Removal of Preservation	6			
4	Mounting	6			
4.1	Installation	6			
4.2	Connected Loads	7			
4.3	Direction	7			
4.4	Coupling Protection / Protective equipment	7			
4.5	Piping	8			
4.5.1	General Remarks	8			
4.5.2	Permitted loads and torques	8			
4.5.3	Suction Pipeline	8			
4.5.4	Pressure Pipeline	9			
4.5.5	Additional Connections	9			

Translation

When shipping to EEA Countries, the operating instructions are to be translated into the respective language of the country where the device is to be used. In the event that discrepancies arise in the translated text, the original operating instructions (German) are to be consulted or the manufacturer is to be contacted in order to clarify the discrepancy.

Copyright

The forwarding and reproduction of this document, the use and disclosure of the contents of this document is forbidden unless explicitly permitted. Failure to comply with this will result in liability for damages.

All rights reserved.

1 General information

The most important operating data can be found on the identification plate. **It must be ensured that the pump type and all technical data correspond to the system / machine project data.** It must be observed that the electric motor is provided with its own identification plate complete with additional technical data. The motor data must also correspond with the system / machine project data.

The separately enclosed operating instructions are also to be observed when dealing with pumps in accordance with EC Directive 2014/34/EU (ATEX). These instructions contain additional instructions and requirements with regards to the correct and proper use of pumps in potentially explosive areas.

The pumps may not be commissioned until the following points have been observed / ensured:

- Inappropriate physical and mental strain placed upon the operation staff must be reduced to an absolute minimum level by taking ergonomic principles into account.
- A safe working environment must be guaranteed. Controls are to be designed and constructed in such a manner that no hazardous situations can occur. Furthermore, such situations may not occur even in the event of faults / breakdown of the control. In particular, the pump may not be unintentionally started. It must also be the case that the supply / discharge lines to and from the pump can also be closed.
- It must be guaranteed that the pump can be safely stopped. Irrespective of the type of operation, the EMERGENCY STOP function must be available and ready for operation at all times. In doing so, it must be taken into consideration that equipment connected to the pump can also be stopped in the event that a hazard can occur if such equipment continues to be operated.
- The supply / discharge lines must be able to withstand the possible internal and external pressure loads
- By implementing suitable precautions, it must be ensured that no injuries can occur by touching the pumps, e.g. with regards to extreme temperatures.

- When conveying materials that pose a hazard to health / environment, it must be ensured that these materials can also be collected and taken away safely. Any risk with regards to inhalation, ingestion as well as contact with the eyes, skin and mucus membranes must be prevented.

1.1 Design

Horizontal and vertical, single-stage or multi-stage ring section pumps, with or without an electric drive unit, on a common bed-plate or unit-construction pumps, available in different construction materials, sizes and with different shaft sealings.

1.2 Intended Use

Temperature:

LUB(L):	-40 °C - 140 °C
LTU:	-40 °C - 120 °C (140 °C)

Operating Pressure:

LUB(L):	10bar
LTU:	25bar

Viscosity:

LUB(L):	≤115 mm ² /s
LTU:	≤ 115 mm ² /s

Ambient Temperature: -20 °C bis 40 °C

Power adjustment

The power of the motors is to be reduced in accordance with the guidelines provided by the motor supplier in the event that the motors are positioned in ambient temperatures of above 40 °C or in a location that is more than 1000m above sea-level.



The conveying of liquids that may chemically corrode the pump material or that contain abrasive components will destroy the pumps. The conveyed material must be suitable for use with the pump material.

The power consumption of the pump proportionally changes based upon the density of the conveyed material. The densities must correspond to the order data in order to avoid excess strain being placed upon the pump and motor

1.3 Place of Operation

The pump unit must be freely accessible for the purpose of supervision, servicing, maintenance, mounting and dismounting.

Avoid using it in corrosive and very dusty surroundings.

The limiting values of the electric drive unit with regard to the insulation material class and the types of protection must be observed.

For other drive units supplied, see the enclosed separate operating instructions.

The most important operational data are mentioned on the type label. The sound pressure L_{pA} following VDI-guidelines 3743 sheet 1 depending on the nominal pump power input P will be seen from the diagram underneath.

Fig. Noise emission

The actual sound level ascertained at place of installation will possibly differ considerably from these values due to the operating conditions and the conditions of installation.

Increased noise emissions may be caused by cavitation, faulty / worn bearings or vibrations. Installation, maintenance and service instructions are to be observed.

2 Security

This operating manual gives basic instructions

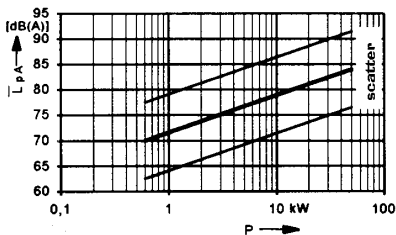

which are to be observed during installation, operation and maintenance of the pump. It is therefore imperative that this manual be read by the responsible personnel/operator prior to assembly and commissioning. It is always to be kept available at the installation site.

It is not only the general safety instructions contained under this main heading safety that are to be observed but also the specific information provided under the other main headings.

2.1 Identification of Safety Instructions in the Operating Manual

Safety instructions given in this manual non-compliance with which would affect safety are identified by the following symbol:



see DIN 4844-W9

or where electrical safety is involved, with



see DIN 4844-W8

Instructions non-compliance with which would give rise to malfunctioning of the machinery are identified by the word

CAUTION

It is imperative that signs affixed to the machine, e. g.

- arrow indicating the direction of rotation
- symbols indicating fluid connections

be observed and kept legible.

2.2 Qualification and Training of Operating Personnel

The personnel responsible for operation, maintenance, inspection and assembly must be adequately qualified. Scope of responsibility and supervision of the personnel must be exactly defined by the plant operator. If the staff does not have the necessary knowledge, they must be trained and instructed, which may be performed by the machine manufacturer or supplier on behalf of the plant operator. Moreover the plant operator is to make sure that the contents of the operating manual are fully understood by the personnel.

2.3 Hazards in the Event of Non-Compliance with the Safety Instructions

Non-compliance with the safety instructions may produce a risk to the personnel as well as to the environment and the machine and results in a loss of any right to claim damages.

For example, non-compliance may involve the following hazards:

- Failure of important functions of the machine/plant
- Failure of specified procedures of maintenance and repair
- Exposure of people to electrical, mechanical and chemical hazards
- Endangering the environment owing to hazardous substances being released



Injuries to hands can occur during maintenance and repair works. Ensure that all safety instructions are observed.

Danger areas on the pump

During maintenance and cleaning work, an area measuring approximately 1 m around the pump will serve as a danger area. This area may also be increased in size in the event of faults. The operating area is only located at the operation elements.

2.4 Compliance with Regulations Pertaining to Safety at Work

When operating the pump, the safety instructions contained in this manual, the relevant national accident prevention regulations and any other service and safety instructions issued by the plant operator are to be observed.

2.5 Safety Instructions relevant for Operation

- If hot or cold machine components involve hazards, they must be guarded against accidental contact.
- Guards for moving parts (e.g. coupling) must not be removed from the machine while in operation.
- Any leakage of hazardous (e.g. explosive, toxic, hot) fluids (e.g. from the shaft seal) must be drained away so as to prevent any risk occurring to persons or the environment. Statutory regulations are to be complied with.
- Hazards resulting from electricity are to be precluded (see, for example, the VDE Specifications and the bye-laws of the local power supply utilities).

2.6 Safety Instructions relevant for Maintenance, Inspection and Assembly Work

It shall be the plant operator's responsibility to ensure that all maintenance, inspection and assembly work is performed by authorized and qualified personnel who have adequately familiarized themselves with the subject matter by studying this manual in detail.

Any work on the machine shall only be performed when it is at a standstill, it being imperative that the procedure for shutting down the machine described in this manual be followed.

Pumps and pumps units which convey hazardous media must be decontaminated.

Replacement parts that have not been supplied by the manufacturer are not tested and not approved for use. The installation and usage of such replacement parts can have a negative impact upon the pump characteristics.

The manufacturer is not liable for any damages caused by the usage of non-original parts.

On completion of work all safety and protective facilities must be re-installed and made operative again.

Prior to restarting the machine, the instructions listed under Initial commissioning are to be observed.

2.7 Unauthorized Alterations and Production of Spare Parts

Any modifications may be made to the machine only after consultation with the manufacturer. Using spare parts and accessories authorised by the manufacturer is in the interest of safety. Use of other parts may exempt the manufacturer from any liability.

2.8 Unauthorized Modes of Operation

The reliability of the machine delivered will be only guaranteed if it is used in the manner intended, in accordance with our order documentation, especially with the order confirmation.

The limit values specified in the data sheet must under no circumstances be exceeded.

3 Transport and Intermediate Storage

3.1 Transport

The pump unit must be transported in a level or horizontal manner.

CAUTION When transporting the complete pump unit by crane, mount the ropes as shown in the figure.

The crane facility and the ropes must be of sufficient capacity. The ring loop of the motor must not be used for transport of the complete pump unit.

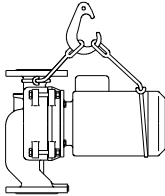

Fig. 2.1a Pumps of structural form LUB

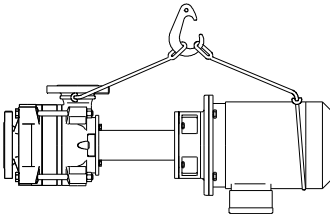

Fig. 2.1b Pumps of structural form LT



A pump that is insufficiently secured can lead to persons being seriously injured.

Hoisting equipment and slinging belts are to be sufficiently measured for the entire weight of the pump. If necessary, ensure that the pump is secured during transport with the use of appropriate slinging equipment. The pump is only to be positioned on a surface that is sufficiently solid and is level in all directions.

3.2 Intermediate Storage

On delivery, all pumps are preserved. Thus, they can be stored for 6-12 months. If the storage time is longer or the pumps are not in operation, they must receive additional preservation on the inside. The preservation means (please consult us)

depends on the used materials and conditions of operation.

The storage room must be roofed and well ventilated. Avoid temperatures below zero and high humidity.

3.2.1 Internal Preservation

Close the suction branch securely. Fill the pump with the preservation means and slowly turn the rotor manually. Close the pressure branch securely.



A rotating impeller can cut or crush hands and arms. Do not reach into the pressure or suction sockets of the pump housing.

3.2.2 Preservation Control

Check the filling level of the pump and turn the rotor by hand at regular intervals of 3 months. Refill preservation means, if necessary.

3.2.3 Removal of Preservation

Prior to operation, the pump must be rinsed thoroughly. In the case of additional preservation, the preservation means on the inside must at first be removed.

4 Mounting

4.1 Installation

In general unit-construction type pumps can be mounted at the tank (FOB/LT) or directly in the piping system (LUB) independently of the fitting length.

The only restrictions are the size of the pump units and the load capacity of the connecting elements.

The installation position "motor faced down" is only permitted with the manufacturer's approval.



Physical injury can occur during the pump installation phase. Safety regulations and the generally recognised engineering regulations are to be observed.

The operator is to ensure a direct and barrier-free access to the pump and must also guarantee good visibility conditions. The operator is to protect the pump against environmental impacts (wind, rain, frost, sand, etc.).

4.2 Connected Loads



Work must only be executed when electricity is switched off. Make sure that the system cannot be powered on accidentally.

CAUTION An overload protection system (e.g. motor protection switch, etc.) must be in place in order to protect the pump and the motor.

The separately enclosed motor safety guidelines and instructions are to be observed.

When using motors that are equipped with frequency converters (FC), the safety guidelines and instructions contained in the separately enclosed FC operating instructions are to be observed. An appropriate risk analysis is to be carried out by the system operator due to the fact faults and malfunctions of the frequency converter cannot be completely prevented as a result of electromagnetic radiation.

CAUTION Prior to connecting the pump to the power system, fill it with pumped liquid. The pump must by no means be operated without liquid!

The pump must be connected according to international national requirements as well as according to the requirements of the local mains system. Voltage and frequency must correspond to the winding of the electric drive. For details of the respective winding, see the type label.

The motor must not be operated without motor protection facility.

For motors with explosion protection, the range of temperature of the motor indicated on the type label must correspond to the range of the fuel gas.



Overheating damages the three-phase alternating current motor. Ensure that a sufficient supply of cool air is in place during operation.



Electrical power can lead to death. Ensure that a potential equalisation connection is in place between the pump housing and the building earthing.



Incorrect electrical switching modes will lead to the breakdown current of the three-phase alternating current motor. Observe the switching mode.

4.3 Direction

Switch on the motor briefly in order to check the direction of rotation. The motor must not reach its operational speed. The direction of rotation must correspond to the arrow indicating the direction of rotation on top of the pump. If the direction of rotation is not correct, perform the relevant modifications at the phase-sequence

CAUTION The switching on / operation of opened pumps (outside of the pipe line network) is forbidden.



A rotating impeller can cut or crush hands and arms. Do not reach into the pressure or suction sockets of the pump housing. Secure the pump appropriately when carrying out a rotational direction check.



The dry operation of the pump destroys / damages the mechanical seal and leads to leakage and the discharge of the conveyed material. Ensure that the pump is switched off again immediately after the warm-up phase.



The incorrect rotational direction of the pump destroys / damages the mechanical seal and leads to leakage and the discharge of the conveyed material.

4.4 Coupling Protection / Protective equipment

The pump must not be operated if coupling protection is not fitted. If this coupling protection is not supplied by the manufacturer, the operator of the pump must supply it himself.

CAUTION In the event that hot or cold pump parts lead to hazards, appropriate protective measures (contact protection) are to be installed on-site. Operation without affixed protective equipment is forbidden.

4.5 Piping

4.5.1 General Remarks

Pressure lines are to be laid in accordance with the respectively valid guidelines as well as the relevant accident prevention regulations. Pipe lines and pumps are to be secured against tripping. If required, a safety area is to be provided against tripping.

The flange covers located on the suction and pressure sockets on the pump are to be removed before installing into the pipe line. The containers, pipe lines and connections must be thoroughly cleaned and rinsed before commissioning. It is often the case that welding beads, scale and further contaminants only disengage after some time. These contaminants are to be kept away from the pump by implementing appropriate measures, e.g. using a filter in the suction line.

CAUTION Observe the conveying and connection direction (suction / pressure flange) of the pump. An incorrect conveying direction of the pump can lead to system faults.

The nominal widths of the pipes must be at least as wide as those of the pump connection joints. For adapters, use extension angles of 8°, if possible.

The pipes must be gathered and secured right in front of the pump so that their weight does not affect the pump. The negative effects of variations in temperature and occurring oscillation may be reduced by installing a suitable bellow expansion joint (see section 4.6).

Measuring equipment for supervision of the pump operation is required.

Prior to operation, all parts in contact with liquids must be thoroughly cleaned.

CAUTION

Under no circumstances may the pump be used as a fixed point for the pipe line. No loads or torques arising from the pipe line system, e.g. as a result of twisting, heat expansion, etc. may have an impact on the pump.



Hot and discharged conveyed materials pose a risk to life.
Do not exceed the permitted pipe line forces.

4.5.2 Permitted loads and torques

Maximum permitted loads and torques Data based upon DIN EN ISO 519					
sockets	loads [N]				torques [Nm]
ø DN	F _y	F _z	F _x	∑F*	∑M*
65	781	640	703	1234	770
80	938	769	844	1481	925
100	1256	1013	1125	1969	1050

*∑F and ∑M represent the vector sums of the loads and torques

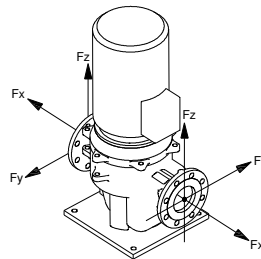

CAUTION The data concerning the loads and torques are only valid for static pipe line strains. All values given for loads and torques are related to the standard cast iron material (0.6025).

4.5.3 Suction Pipeline

The suction pipeline must be as short as possible. Variations in diameter and additional piping must be kept to a minimum. The suction pipeline towards the pump must be rising, the inlet must be descending to prevent an air pocket from being formed. For non-self-priming pumps, installation of a foot valve into the suction pipeline is compulsory in order to avoid that, in case of a standstill, the pump and the suction pipeline run out of liquid during suction operation.

Contamination of the pumped liquid is to be avoided by using a suction hose or a filter. By no means must air penetrate through the liquid level via the suction hose or dirt be whirled up from the liquid pool. Clean the suction hose and filter regularly.

To close the suction pipeline in the case of mounting or maintenance work, a stop valve must be provided near the pump. The stop valve must not be used for adjustment and must be completely open during operation.

4.5.4 Pressure Pipeline

For adjustment, repair and mounting of the pump, a stop valve is to be provided near the pressure joint.

4.5.5 Additional Connections

For the position and dimension of required additional connections as e.g. for rinse, stop and quench liquid, refer to the labels supplied with the pump or to the drawings in the operating instructions. The rinse, stop and quench liquids must be checked at regular intervals. Connections for ventilation and release of the leaked liquid are also described in the drawings.

5 Starting Operation/ Stopping Operation

5.1 Preparations for Initial Operation

Prior to the start, the pump and the suction pipeline must be drained of air and be completely filled with the pumped liquid. The stop valve in the suction or inlet pipeline must be completely open, if there is one. For self-priming pumps, the pump must only be completely drained of air and filled with the pumped liquid.

CAUTION A pump / pipe line that is not de-aerated leads to the destruction / damage of the mechanical seal. Conveyed material may be discharged.

Before commissioning, it must be ensured that the pump and pipe lines have been connected / assembled in accordance with the guidelines and in a fixed manner. The pump may only be operated provided that protective equipment (coupling protection / fan guard) is in place. The pump must be operated with contact protection when dealing with hot conveyed material.

CAUTION Do not block the motor fan with foreign articles. Blockage will lead to the ejection of foreign articles and overheating / breakdown of the motor.

5.2 Initial Starting

The pump must not be started until the outlet stop valve is closed so as to avoid overload of the motor. Immediately after reaching the operational speed, slowly open the stop valve of the pressure pipeline and adjust the operating point.



The pump must never be operated for a longer period if the outlet stop valve is closed. The pump unit will be damaged if the pumped liquid exceeds the permitted temperature.

5.3 Restarting

Do not restart the pump until the pump shaft stands still.

CAUTION Backflow of liquid must not result in a change of direction of rotation of the pump. If this is the case, mechanical seals dependent on direction of rotation may be damaged.

CAUTION Before re-starting the pump, it must be ensured that the pump has not incurred any damage during the downtime and that all safety and protective equipment is affixed.

5.4 Stopping Operation

Close stop valve of the pressure pipeline. If there is a backflow stop and sufficient counter pressure in the pipeline, the stop valve can remain open. Switch off the motor and observe that it slows down smoothly. Close stop valve of the pressure pipeline. If the pumped liquid reaches temperatures below zero and/or if longer periods of standstill occur, the pump must be drained completely and be preserved (see section 3.2.1).

6 Service/Maintenance

6.1 Supervision of Operation

CAUTION The pump is to be secured against being unintentionally switched on during maintenance and cleaning work. Work may only be carried out provided that the system / pump is in a pressure-free condition.

Maintenance and cleaning work may only be carried out by expert staff members. The expert staff members must be provided with personal protective equipment.

Ensure that the pump is cleaned and maintained at regular intervals in order to be able to ensure a trouble-free operation.

CAUTION Conveyed material that poses a hazard to health can place a person's health at risk. The operator is to equip the system with collection equipment or other appropriate protective measures. Personal protective equipment such as gloves and protective goggles must always be worn.

Ensure that the pump runs free of vibration and smoothly. Ensure that the pump runs in a quiet and vibration-free manner. Inspect the pump for loose connections at regular intervals (an interval of 4 months is recommended). Regularly remove deposits of dust as well as contaminations.



Physical injury can occur when carrying out maintenance and cleaning work on the pump.

Safety regulations and the generally recognised engineering regulations are to be observed.

The pump must by no means be operated without liquid.

There is only a minimal or invisible loss of leakage (steam) if the mechanical seals function correctly.

Do not operate the pump for a longer period with a closed stop valve.

The maximum permitted environmental temperature is 40°C. The storing temperature measured at the motor or pump casing may exceed the environmental temperature by 50°C. It must not exceed 90°C. Only operate the pump at a higher temperature with the manufacturer's approval.

Installed pumps must be powered on and off briefly once a week in order to guarantee that they are ready for operation.



Insufficient rotary motion of the motor shaft will lead to the impeller becoming stuck and the mechanical seal breaking down. This can lead the

discharge of the conveyed material.

6.1.1 Shaft Bearing

Under normal operation conditions, replace the motor bearings after 20.000 hours of operation or at the latest after 2,5 years. In the case of bad operation conditions, as e.g. a high environmental temperature or a corrosive and dusty environment, the motor bearings must be checked at an earlier date and, if necessary, be replaced.

Faulty / worn bearings lead to subsequent damage and can result in increased noise emission.

6.1.2 Mechanical Seal

The mechanical seals are maintenance-free. If leakages occur after a longer period of operation, replace the complete seal.

CAUTION

When dealing with conveyed materials that pose a hazard to health and to the environment, the operator is to equip the system with collection equipment or other appropriate protective measures. Personal protective equipment such as gloves and protective goggles must always be worn.

6.2 Maintenance

6.2.1 Preparation



In order to make sure that the pump cannot be started, separate the power cable from the motor. Secure the unit against accidental switch-on.

The stop valves located in the pressure and suction line are to be closed and secured against unauthorised opening. The pump casing must have reached the environmental temperature and be drained of liquid and pressure. In the case of pumps in unit-construction with mounting flange, the container must be drained completely.



Leaking conveyed material can injure hands and arms. Ensure that the pump housing is in a pressure-free condition. Only then may the pump be emptied.



When dealing with pumps that have been used to convey materials that pose a hazard to health / to the environment, ensure that no danger to persons and the environment can occur when emptying the pump. Wear appropriate protective clothing and, if required, protective mask.

The rinsing liquid used and the remaining liquid located in the pump must be professionally collected and disposed of without posing any hazards to persons or to the environment.

6.2.2 Dismounting

By no means use force while dismounting the pump.



Pumps that are used to convey material that is hazardous to health and to the environment must be decontaminated. When releasing the material, ensure that no danger to persons and the environment can occur when emptying the pump. Legal requirements are to be observed and adhered to.



The pump must always be secured against tipping over. There is a risk of tipping over when loosening the pump from the outside of the pipe line network. Persons can be seriously injured if the pump tips over.

During the transport phase, ensure that the pump is secured using appropriate slinging equipment. The pump is only to be positioned on a surface that is sufficiently solid and is level in all directions.

CAUTION The pump may only be dismantled when in a pressure-free, empty, de-contaminated (if required) and secured condition. Protective clothing and protective mask must be worn if required.

Proceed as follows for the different pump types: For fixed parts of the casings, impellers and couplings, use appropriate dismounting facilities. Impellers, which cannot easily be removed from the shaft, can be pushed back from the shaft by means of two hexagon screws.

6.2.2.1 6.2.2.1 Pump

The pump is always dismounted on the suction side and with the shaft in a horizontal position. Refer to enclosed drawings on page 10, 11 and 12 or in the supplementary sheet for the dismounting sequence.

6.2.2.2 6.2.2.2 Dismounting of Mechanical Seal

In order to replace the mechanical seal, the pump must be dismounted (see Fig. 6.2.2) first. After that the pump must be dismantled before the seal can be removed. Dismantle the pump in the sequence shown in the exploded view diagrams, pages 10,11 or 12. Remove impeller (230), casing (108,117), key (940.1) and the circlip (932), pull the delivery casing (107) off the shaft with the mechanical seal (433).

6.2.2.3 6.2.2.3 Motor

For vertical pumps and unit-construction pumps, it is not necessary to dismount the pump unit. The pump can remain in the piping. First, remove the coupling protection (681) and loosen the hexagon screws (901.4) of the coupling. After having loosened the hexagon screws (901.1) at the motor flange, remove the motor from the pump.

6.2.3 Mounting

6.2.3.1 General Remarks

Prior to mounting, all parts must be cleaned thoroughly. Remove remaining parts of the seals. Slight scratches and grooves on the shaft near the shaft seal and on other sealing surfaces of the casings are to be polished with linen. If this is not possible, replace the parts. Gaskets must always be renewed. Check O-rings for damage and replace them, if necessary.

Mounting is effected in the reverse order of dismounting. Heat up the coupling joints of rigid couplings to approximately 250 °C prior to mounting them onto the shaft.

The starting torques for the tie bolts and locking screws non lubricated condition are displayed in fig. 6.2.3.1a.

thread	M 10	M 12	M 14	M16	M20
torque Nm	30	50	75	110 70*	120

* for pumps with more than 4 tie bolts

Abb. 6.2.3.1a Starting torque

6.2.3.2 Mounting of the Motor

For initial mounting of motor and pumps with rigid coupling, first of all, remove the transport safeguards of the lantern (341) or of the intermediate flange (722), then remove the motorside coupling half (844).

Subsequently, put this part onto the motor shaft. This coupling half must be next to the motor shaft collar. Tighten screws (904.1), join motor and pump centrally without tilting them. Tighten screws (901.1) between motor and lantern (341) or intermediate flange (722) and then coupling screws (901.4).

CAUTION The inner parts of the pump will be damaged if motor and pump are connected and the motorside or pumpside coupling half has been installed incorrectly or not at all.

6.2.3.3 Mounting of Mechanical Seal

CAUTION When mounting the mechanical seals, you must proceed very carefully and with precision.

Do not touch the surfaces of the seal. Do not damage the sealing parts. To facilitate the mounting, moisten elastomer with low-surface tension water.



Mechanical seals and sealing parts with elastomer made of EP rubber must by no means come in contact with oil or grease.

The shape of spare mechanical seals may differ from those of the installed mechanical seal. However, the dimensions of the spare mechanical seal are the same and for that reason it can be replaced.

To avoid distortion of the counter-ring, mechanical seals with doubled PTFE-wrapped sealing O-rings are additionally secured by a leading pin inside the casing. The pin must be removed when replacing the type of mechanical seals and when using a type with different O-ring material.

For details of the individual types of mechanical seals observe the following procedures.

CAUTION Observe the enclosed, separate mounting instructions for those types of mechanical seals which are not listed.

1. Stressed mechanical seal independent of direction of rotation with elastomer bellows (fig. 6.2.3.3a)

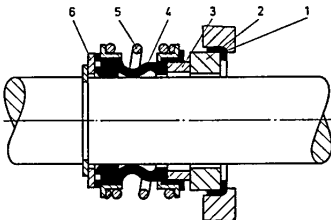

Fig. 6.2.3.3a

Carefully press angle collar (1) together with counter ring (2) into the counter ring fit. Twist the rotating unit (3,4,5) onto the shaft as far as the counter ring. Put on supporting ring and mount circlip and/or push shaft sleeve for mechanical seal onto the shaft.

2. Stressed mechanical seal dependent on direction of rotation with conical springs (fig. 6.2.3.3b)

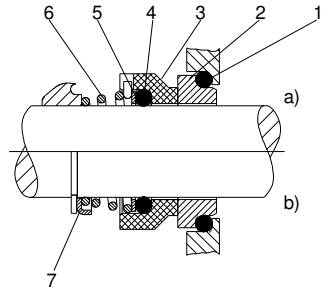

Fig. 6.2.3.3b

Insert O-ring (1) into counter ring fit and carefully press counter ring (2) into it.

Push mechanical seal (3) onto the shaft as far as the counter ring. Press O-ring (4) into the mechanical seal by means of the supporting ring. The pivot of the pressure spring (6) must be situated in the groove of the mechanical seal ring.

- a) Put on impeller (230)* (only pumps of type CB..., ECD..., SU...) or
- b) Put on locking ring (7). Mount circlip (932)* and/or shaft sleeve for mechanical seal (516)*

*see drawing in the operating instruction

CAUTION Prior to start pump again, the pump must be filled with liquid to be pumped.

7 Disturbance

CAUTION

To eliminate disturbance, the pump must have reached the environmental temperature and must be drained of air and pressure.

	Pump is blocked	Coupling fault	Heads too low	Rates of flow too low	Bearing temperature too high	Pump operates badly	Leakages at the casing	Overload of the drive	Shaft seal leaks badly	Motor protection activated	Pump is becoming too hot	Cause	Elimination
			•	•								Pump and/or suction pipeline is not completely drained of air/filled	Drain of air and fill
			•	•		•				•		Suction level too high, NPSH value of the unit too high	Completely open stop slide in the suction pipeline, check suction bag/footing valve, if necessary, increase liquid level, if necessary
			•	•						•		Air inclusion in the pumped liquid too high	Seal suction pipeline once again, check suction bag, increase liquid level, if necessary
			•	•	•					•		Formation of air bag in suction pipeline	Change suction pipeline/attach drain valve
			•	•						•		Direction of rotation incorrect	Check and change phase sequence, if necessary
			•	•								Rates of flow too low	Readjust operating point
			•	•								Wear of inner parts	Replace inner parts
					•			•		•		Pump operates out of tolerance	Readjust operating point
									•			Shaft seal damaged	Replace shaft seal
									•			Stuffing box gland jammed or tightened too heavily	Correct
			•	•	•				•			Air entry through shaft sealing on suction side	Check liquid sealing or replace packing
			•	•								Speed too low	Increase speed ¹⁾
								•		•		Speed too high	Reduce speed ¹⁾
							•					Connecting screws, seals	Tighten connecting screws, replace seals
	•				•							Pump/motor not adjusted	Replace defective parts, adjust pump/motor
	•				•	•						Problems via piping	Check pipe connections/pump fasteners/bearing distance of pipe clips, installation with oscillation absorbers
					•							Insufficient, excessive or wrong lubrication grease	Add, remove or change grease ²⁾
	•											Incorrect coupling gap	Readjust motor
			•	•								Defective bearing	Replace bearing
			•	•				•		•		Density/viscosity of pumped liquid higher than indicated in the order	¹⁾
											•	Motor protection unit set incorrectly or defective	Check motor protection unit, replace it, if necessary
	•											Impeller blocked	Clean interior parts from particles and impurities

¹⁾ Please consult us

²⁾ Only pumps with lubricator

8 Pump View and list of Spare Parts

8.1 LUB 65 · LUB 80

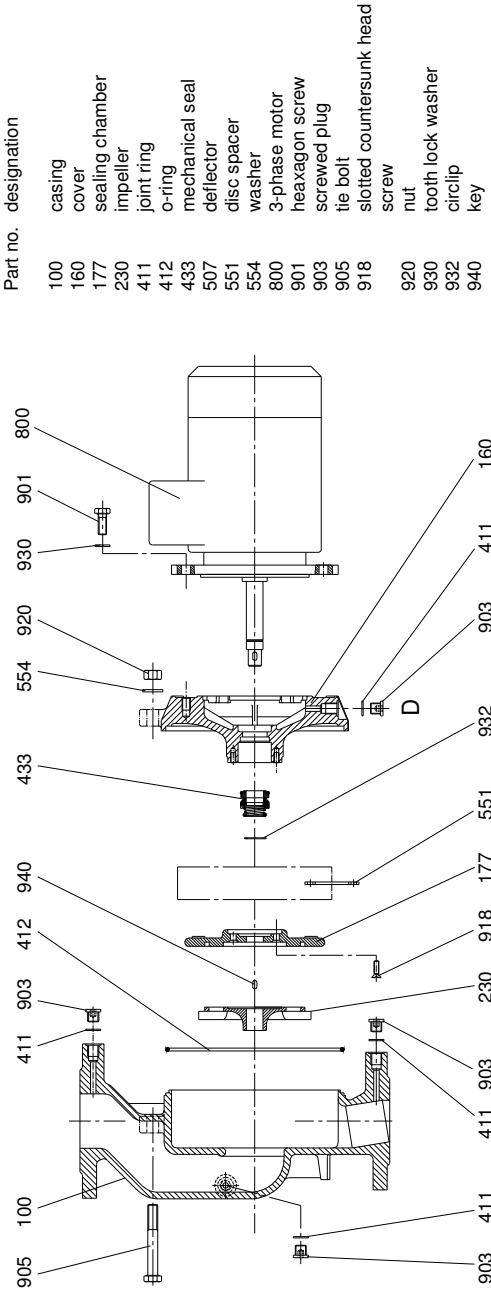

Part no.	designation
100	casing
160	cover
177	sealing chamber
230	impeller
411	joint ring
412	o-ring
433	mechanical seal
507	deflector
551	disc spacer
554	washer
800	3-phase motor
901	hexagon screw
903	screwed plug
905	tie bolt
918	slotted countersunk head
920	screw
930	nut
932	tooth lock washer
932	circclip
940	key

When ordering spare parts, please indicate serial no., type no. and parts no. by all means.

8.2 LUBL 65 · LUBL 80

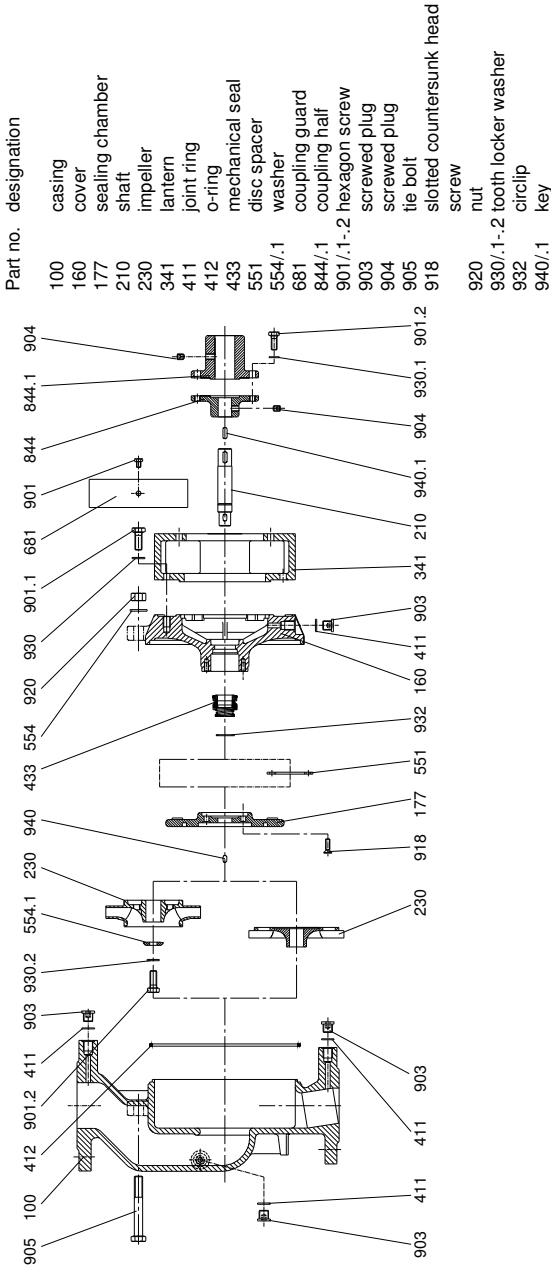

When ordering spare parts, please indicate serial no., type no. and parts no. by all means.

8.3 LTU

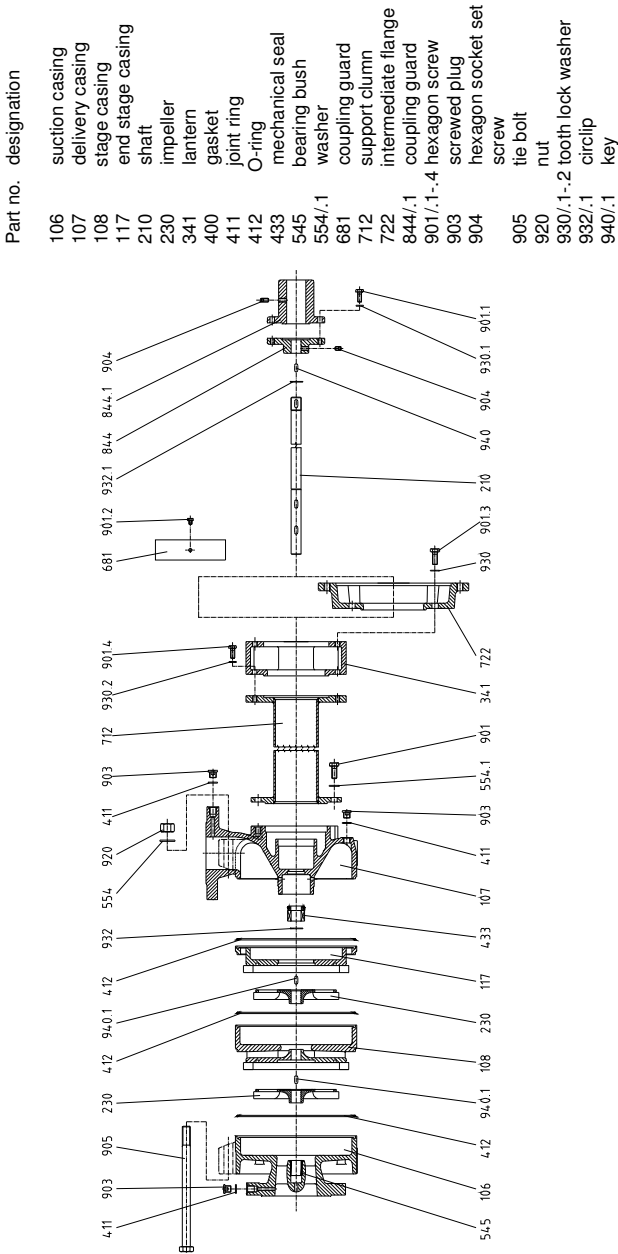

When ordering spare parts, please indicate serial no., type no. and parts no. by all means.

**EG Declaration of Conformity
In accordance with EC Machinery Directive 2006/42/EC, Appendix II, 1 A**

We, EDUR Pumpenfabrik Eduard Redlien GmbH & Co. KG
Edisonstraße 33
D-24145 Kiel

hereby declare that the compact design rotary pump – see cover sheet for information regarding pump model, conforms to all of the relevant regulations of EC Machinery Directive 2006/42/EC. The protection objectives of the low voltage directive were observed in accordance with Appendix I, No. 1.5.1 of the machinery directive. The following harmonised standards applied:

DIN EN ISO 12100 DIN EN 809

Person responsible for the documentation: Mr. T. Kaeding

**Declaration of Incorporation
In accordance with EC Machinery Directive 2006/42/EC, Appendix II, 1 B**

We, EDUR Pumpenfabrik Eduard Redlien GmbH & Co. KG
Edisonstraße 33
D-24145 Kiel

hereby declare that the incomplete compact design rotary pump – see cover sheet for information regarding pump model – supplied without motor conforms to the following essential requirements of EC Machinery Directive 2006/42/EC, Appendix I:

1.1.1.; 1.1.2.; 1.1.3.; 1.1.5.

The following harmonised standards applied:

DIN EN ISO 12100 DIN EN 809

This incomplete machine may only be put into operation after it has been determined that the machine into which this incomplete machine is to be installed, conforms to the regulations of the machinery directive.

Person responsible for the documentation: Mr. T. Kaeding

